

UNIVERSAL PROFESSIONAL PARTS





PERFORMANCE
MIGHTY MITE
QUALITY

BODIES

All bodies are made from American Pacific Coast Maple or American Ash. Finish bodies are sprayed with 11 coats of color finish and are wet sanded between coats which gives it that final mirror finish. All body styles are available in the assortment of colors shown on this page.

MM2700F-CRS



MM2700F-CMB

MM2700A



MM2705F-R



MM2705F-BK

MM2705F-IV



MM2702F-BLB



MM2702F-IV

MM2702F-2TS



Pickups

Powerful, fully shielded low-noise pickups for high out put. These high resistance pickups feature "staggered" pole pieces, 4 conductor shielded wiring, potted for feedback suppression and specially wound for high-end punch. Our array of pickups range from '57 Humbucker to our Vintage Single-Coil Alnico & Ceramic and state of the art Bass Pickup, active and passive.

If you are not happy with the sound of this pickup, please call within 30 days of purchase for our exchange policy



MMVPSS-F/WH
MMVPSS-M/WH
MMVPSS-R/WH

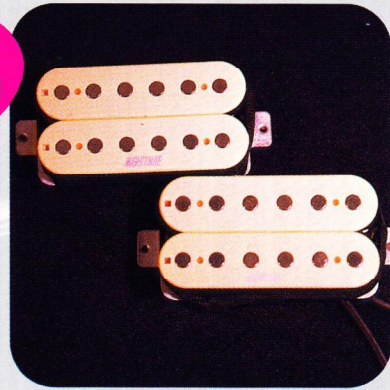

MMHG-F/CR
MMHG-R/CR

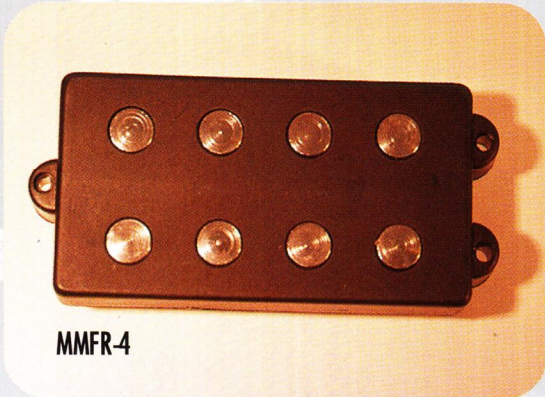

MMFR-4



MMPSS-F/BK
MMPSS-M/BK
MMPSS-R/BK



MMP90-F/CR



MMHG-F/BK
MMHG-R/BK



MMSA4-F/BK
MMSA4-R/BK

Also available in Passive and 5 String

Strat®, P Bass®, Jazz Bass® and Telecaster® are trademarks of Fender® Musical Instruments Corp., MIGHTY MITE® is not affiliated with Fender® Musical Instruments Corp., Steinberger® and Les Paul® is a trademark of Gibson® Musical Instruments Co., which is not affiliated with MIGHTY MITE® Parts. Floyd Rose® is not affiliated with MIGHTY MITE® Parts.



Guitar Necks

Replacement necks from the most popular guitars, completely shaped, fretted, inlay and finish with clear satin lacquer. Our necks are made from the finest Northern Michigan or Canadian Hard Rock Maple and are comparable in quality and design to the

best original factory necks. Truss rod, dot position markers, side dot markers and finish nickel silver frets are installed. In addition to standard factory necks our Graphite and Left Handed Necks provide a full array of necks to choose from.

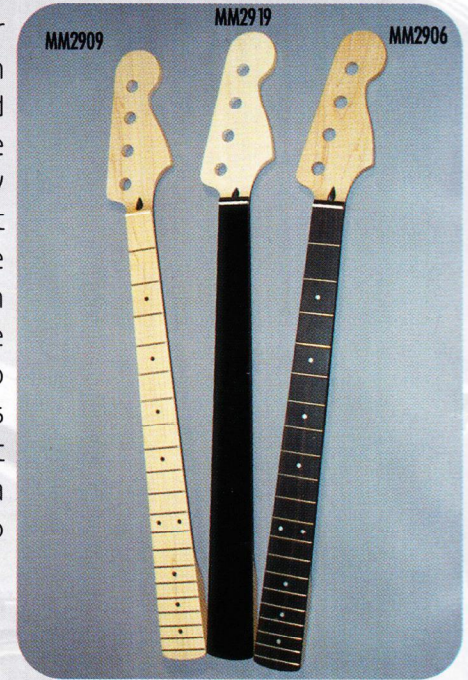
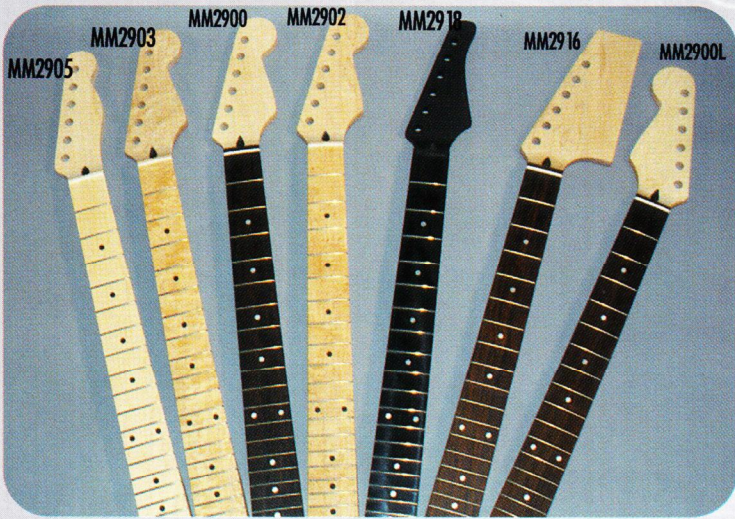

Stratocaster®, Telecaster®, Precision Bass® are registered trademarks of Fender Musical Instruments Corporation (FMIC). Mighty Mite® is not affiliated with FMIC. Mighty Mite® is licensed by Fender Musical Instruments Corporation to sell replacements necks for Fender® and Squier® by Fender Guitars and Bases.

Pickguards

Our Pearloid Pickguards present traditional brilliance as well as beauty.

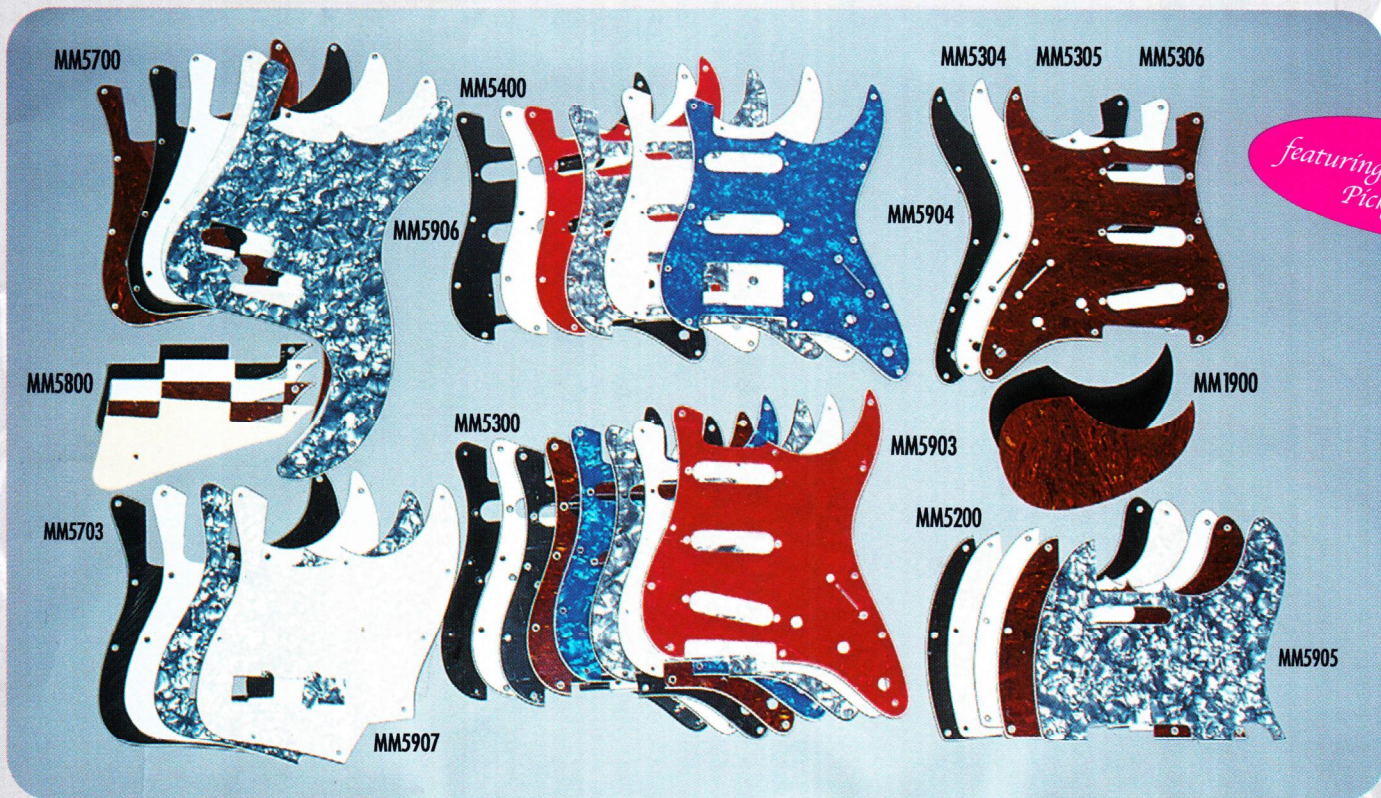

Now featuring Left Handed Pickguards

Machine Heads

High quality replacement machine heads that meet or exceeds machine heads from the worlds finest guitar factories.

All die cast machine heads are guaranteed for 5 years to the original purchaser.



MM6000C



MM6009C



MM6003C

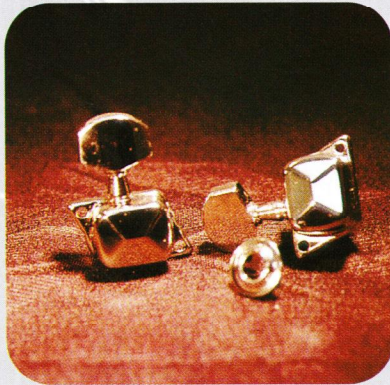

MM6004
MM6004-6L



MM6005G



MM6006G



MM6008C

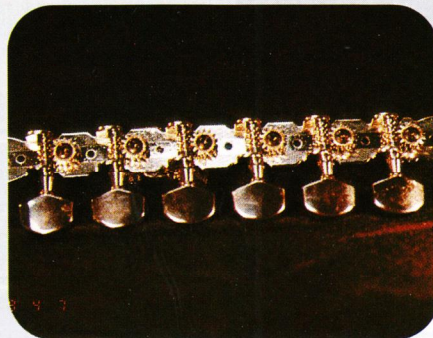

MM6007C

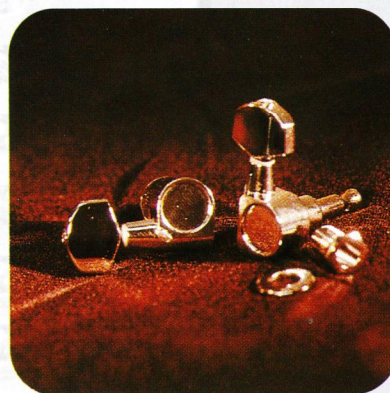

MM6001C



Tremolo Systems

MMT124



The **MMT124** brings back the vintage Tremolo look of the yesteryears for the hipper look of today.

MMT112

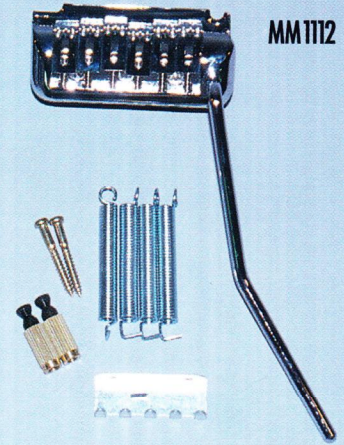

MMT115

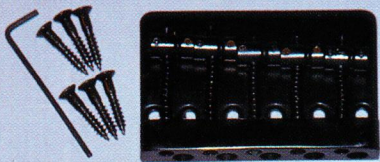

MMT110

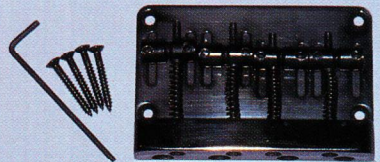

MMT102

MMT100

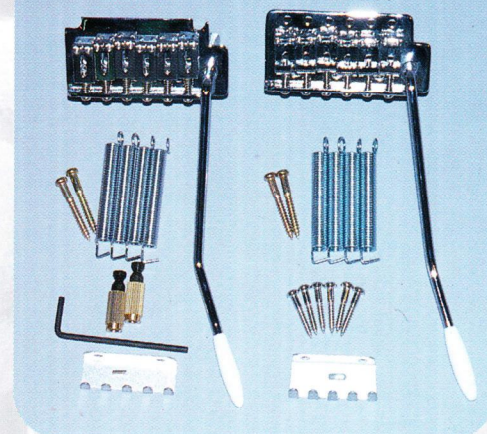

MMT102

A full action floating trem bridge that floats against two beveled mounting post for an easier more accurate action and greater back trem.

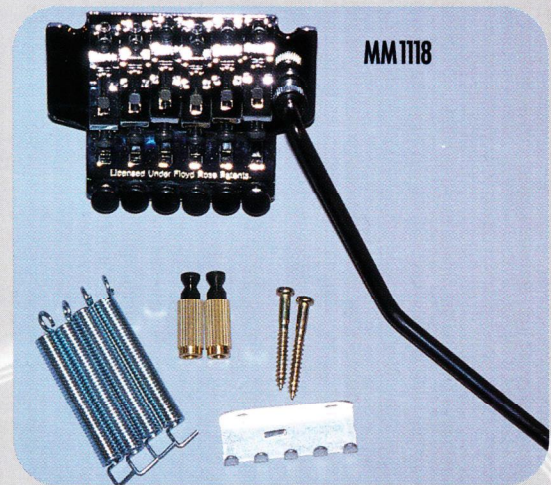

FLOYD ROSE® AND FLOYD ROSE® III LICENSED TREMOLO REPLACEMENT PARTS

THE FLOYD ROSE® AND FLOYD ROSE® III LICENSED TREMOLO PARTS KIT.
Packaged in a durable Lucite Shop Kit.

| Parts | Description | Ref. No. |
|--------|----------------------------|----------|
| MM3000 | Base Plate | 1 |
| MM3100 | Fine Tuner Adj. Spring | 2 |
| MM3200 | Spring Holder Plate | 3 |
| MM3300 | Trem Block/Locking Screw | 4/5 |
| MM3500 | Saddle Lock Down Screw | 6 |
| MM3600 | String Holder Block | 7 |
| MM3700 | Bridge Saddle 1 & 6 | 8 |
| MM3701 | Bridge Saddle 2 & 5 | 8 |
| MM3702 | Bridge Saddle 3 & 4 | 8 |
| MM3800 | Fine Tuner Screw | 9 |
| MM3900 | String Holder Locking Blot | 10 |
| MM4000 | Stud & Stud Insert | 11 |
| MM4100 | Tremolo Arm Bushing | 14 |
| MM4100 | Key Washer | 15 |
| MM4100 | Bottom Washer | 16 |
| MM4100 | Tremolo Arm Lock Nut | 17 |
| MM4200 | Spring Claw Hook | 18 |
| MM4300 | Tremolo Spring | 19 |
| MM4400 | Tremolo Claw Hook Screw | 20 |

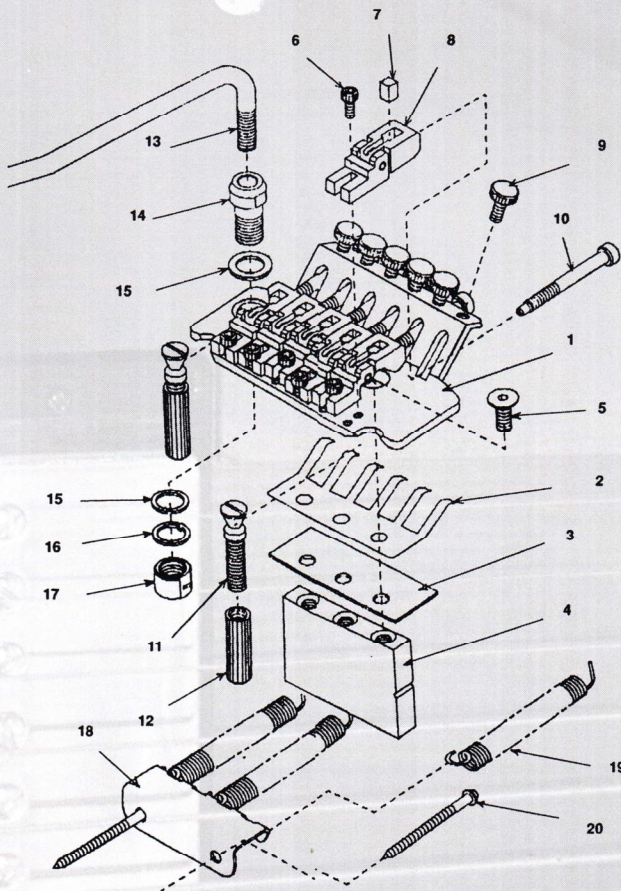



PERFORMANCE
MIGHTY MITE
QUALITY

Knobs

Our 909 series dome knobs feature allen set screw to help securely lock them into place for a better grip.

Switches

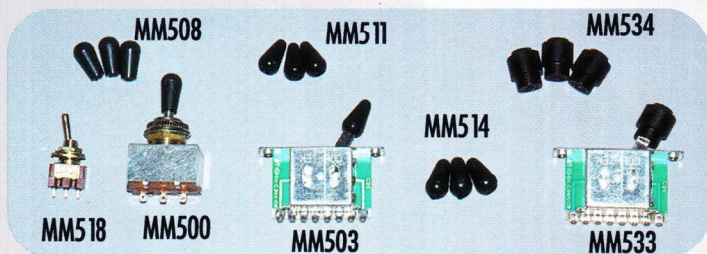

Control Pots



NEW EQ'S

MM505

3-band plus volume control, active equalizer. The spec of Frequency-response 20 Hz-30KHz, Control Range: = 35dB Control Freq: Bass 30 Hz, Mid 550 Hz, Treb 5KHz. New great sound and versatility!



MM505

MM7580

Also available with Slim Jim® (MM555 & MM7585)



Acoustic/Electric Guitar Electronics

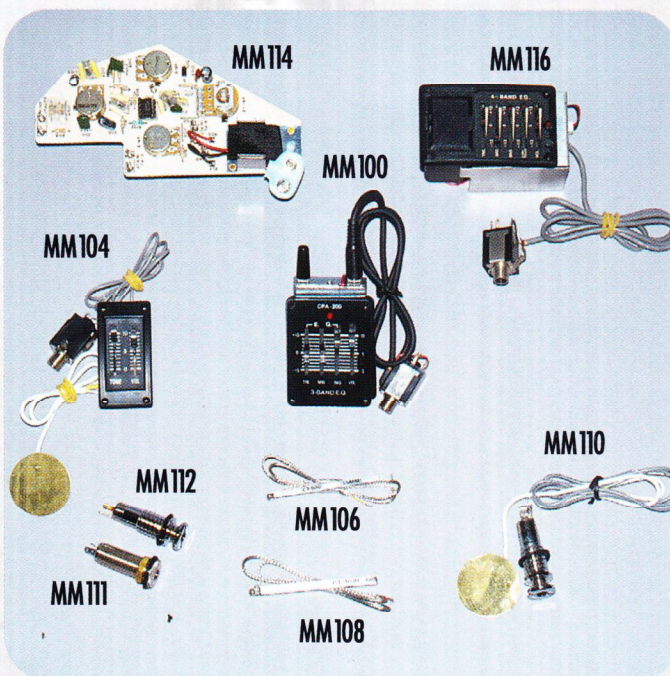

MM7580

4-band plus volume control active equalizer. The spec of: Freq-response, 20Hz-30KHz Control Range: =35dB Control Freq: Bass 60 Hz, Mid 650 Hz, Treb. 1.5 KHz, Prese 10 KHz. The highest quality, most natural sound!

Hardware

MM5614 MM5613

A new line German made super security lock that locks your strap to your instrument with quick release. Patented securely (Shown on cover)

MM5612C

Contemporary Style Strap Buttons with screws and thick felt pad. These strap buttons have a extra large scallop to hold those thick leather strap ends. They look great too.

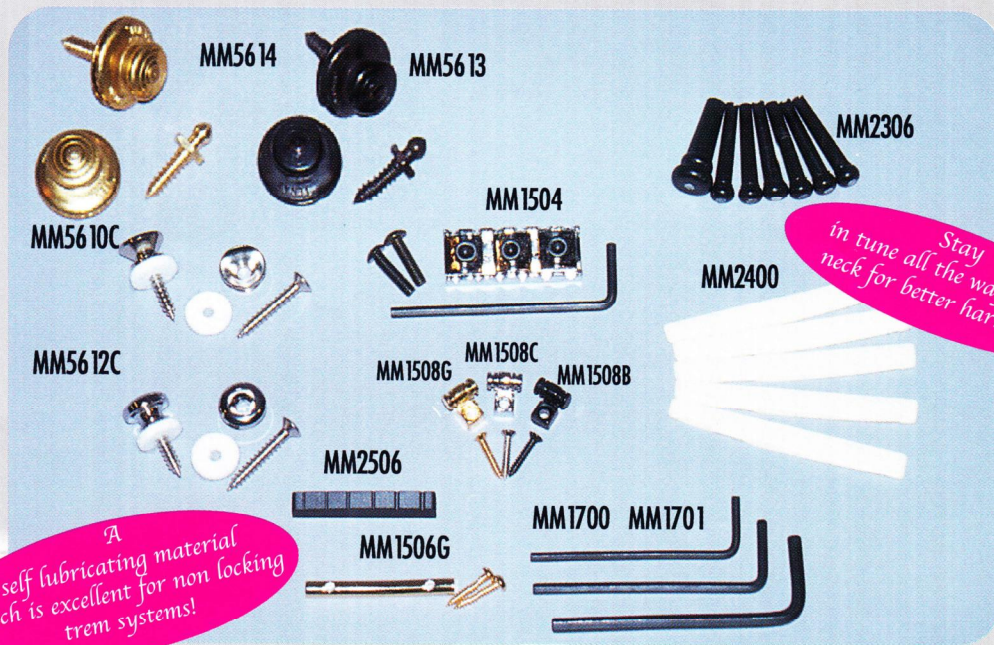

A self lubricating material which is excellent for non locking trem systems!

Stay in tune all the way up the neck for better harmonics!

MM2500

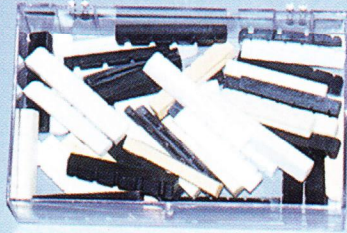

MM302G

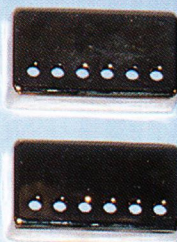

MM300B

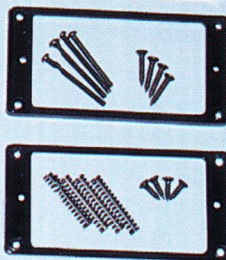

MM309C

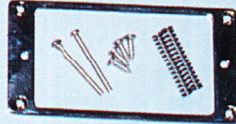

Pickup Mounting rings for Double Coil Pickups 1 ea. for the neck position and bridge position.



MM309C

Most metal mounting rings are only 1/16" thin. Ours measure a full 1/8". They won't bend or break and they give any guitar as much mor professional look. Set includes metal mounting ring with springs and screws.



"Mighty Mass" Bass Bridges

Designed for 4,5, and 6 string basses are the "Baddest" bass bridges you have ever played. With maximum comfort and maximum mass, these bridges are made of solid brass for superlative tone and sustain. String changes have never been easier, thanks to the convenient string slot. The string spacing is the most natural you have ever played. Upgrade to Mighty Mite® "Mighty Mass" performance quality parts.

Bridges & Tail Pieces

MM2102

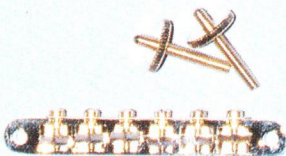

MM2105



MM2206



MM2212



Solid rosewood with beautiful open-pore sealer on the top and sides. Ready for gluing.

MM1204G

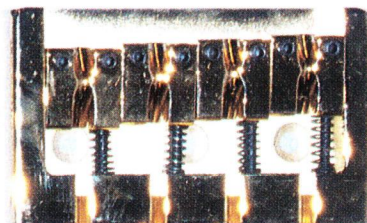
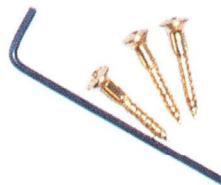
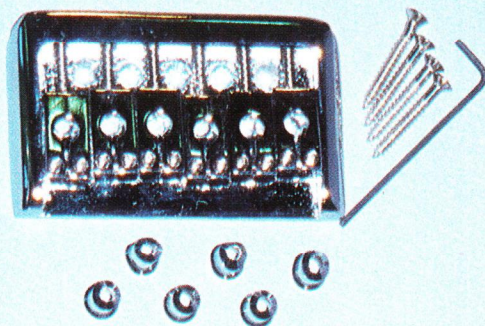

MM1204G

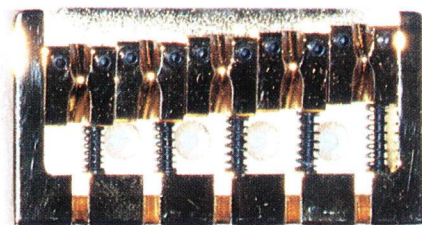

MM1205G

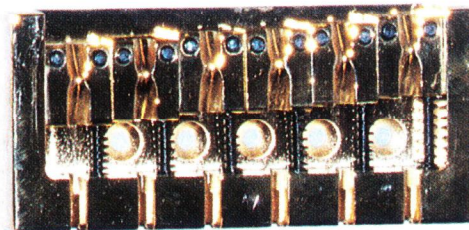
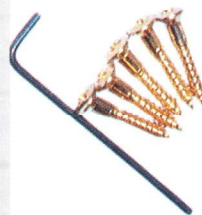

MM1206G

Steinberger® Licensed Headless Tremolo & Bridge System

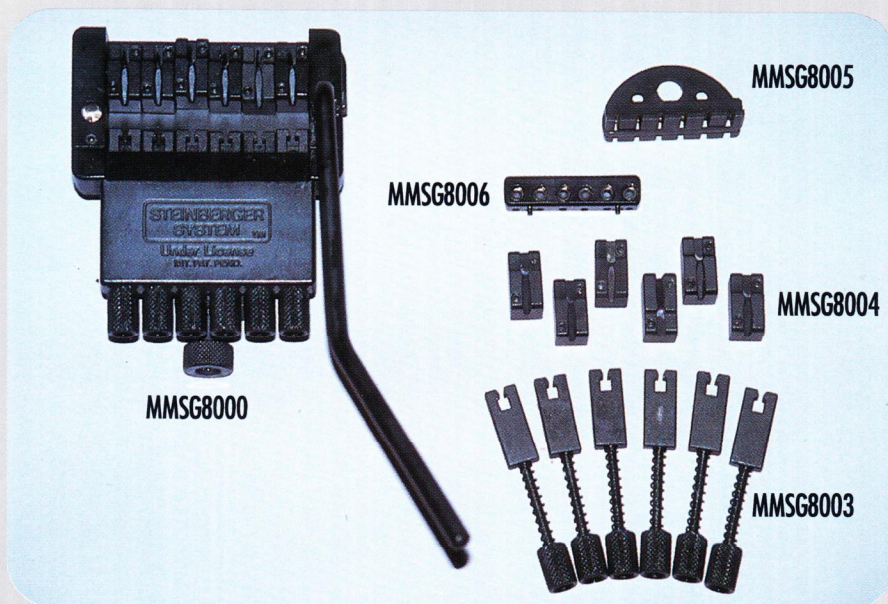

Now supplying all original replacement parts for the original wood neck and body Steinberger® Headless Guitar, 4 String Bass and 5 String Bass.

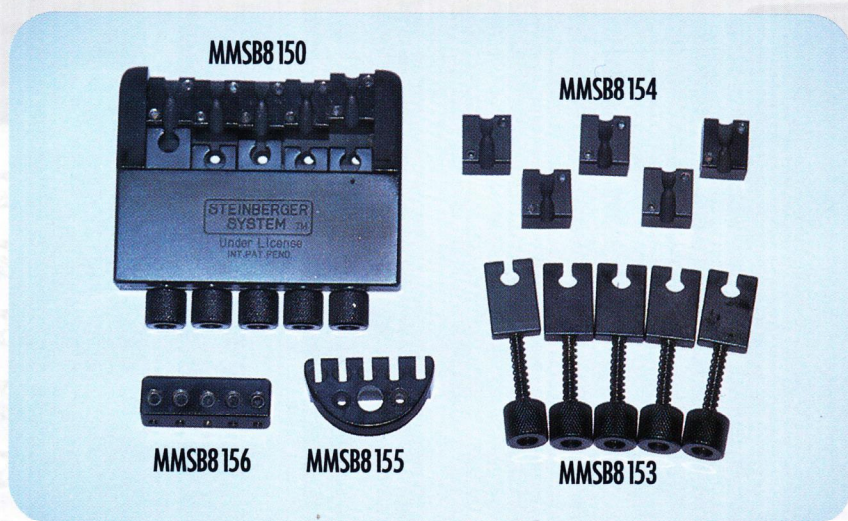
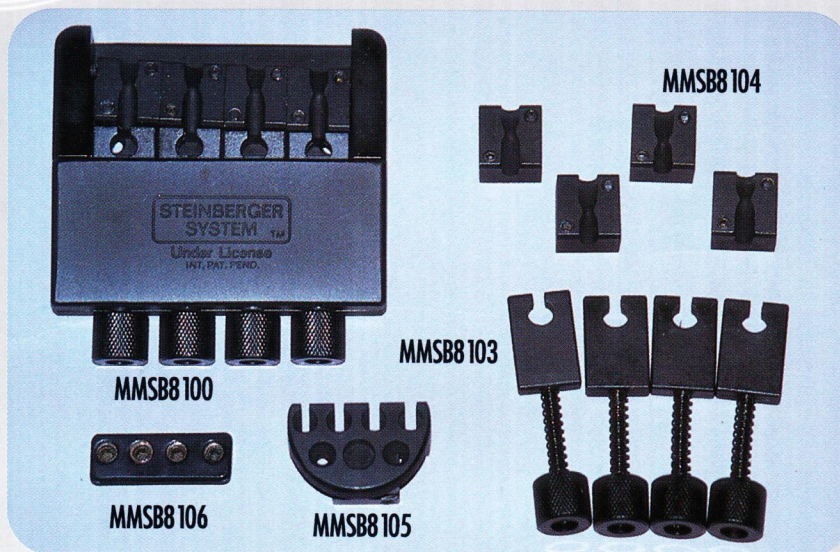



Capo

Designed by Ned Steinberger



Specially designed by Ned Steinberger an easy one hand operation Capo. Useable on all Electric, Acoustic and 12 String. Patent compound action reduces tension for an **effortless quick** change.

NSC5
Quick change Classic Guitar Capo for all nylon string guitars: banjos, mandolins and other instruments with straight fingerboards. Patented easy fast compound action.

Repair Kits



Absolutely a must for all stores that sell and repair guitars!



MMRK2 Repair Kit
Everything you need for over 95% of all guitar repairs conveniently stored in a sturdy reusable compartment box. Includes parts often missing from the sales floor. Replenishment stock is available.

MMSK1 Screw Kit

Plates

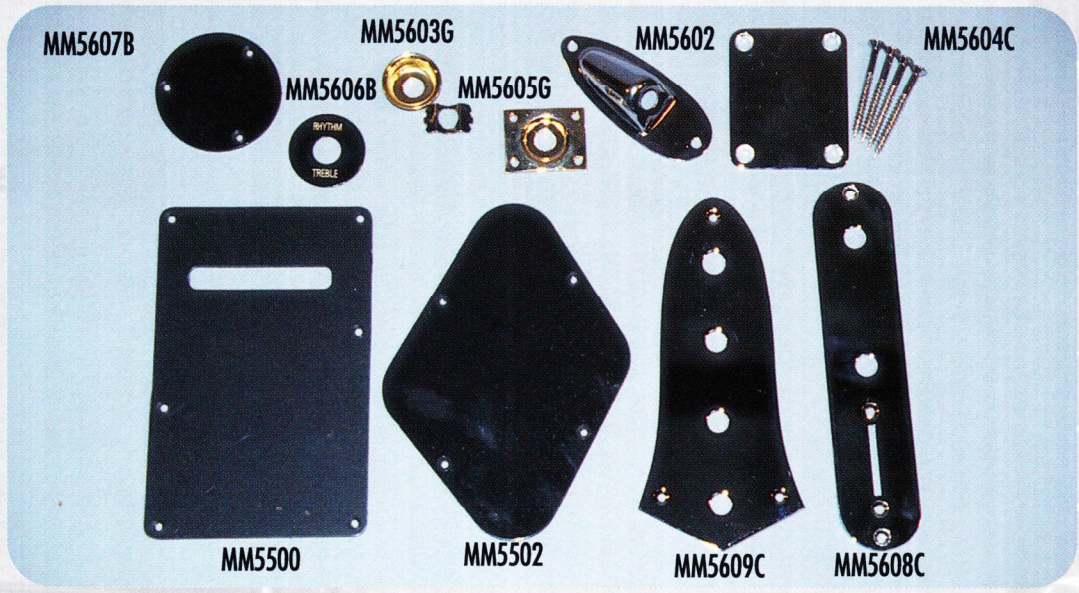

Drum Replacement Parts

Mighty Mite® drum parts are universal and easy to replace for 95% of all drum sets on the market. Manufactured to meet or exceed the hardware from the worlds best drum factories.

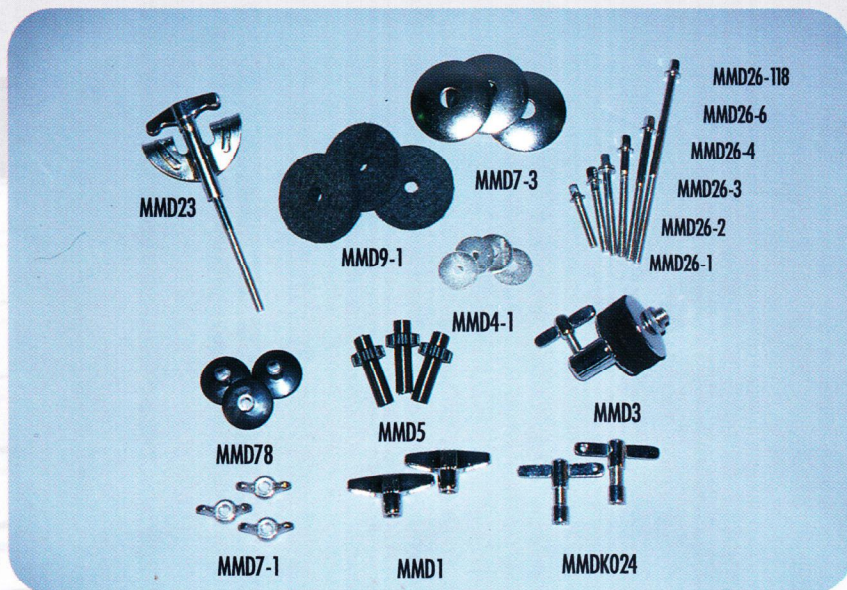
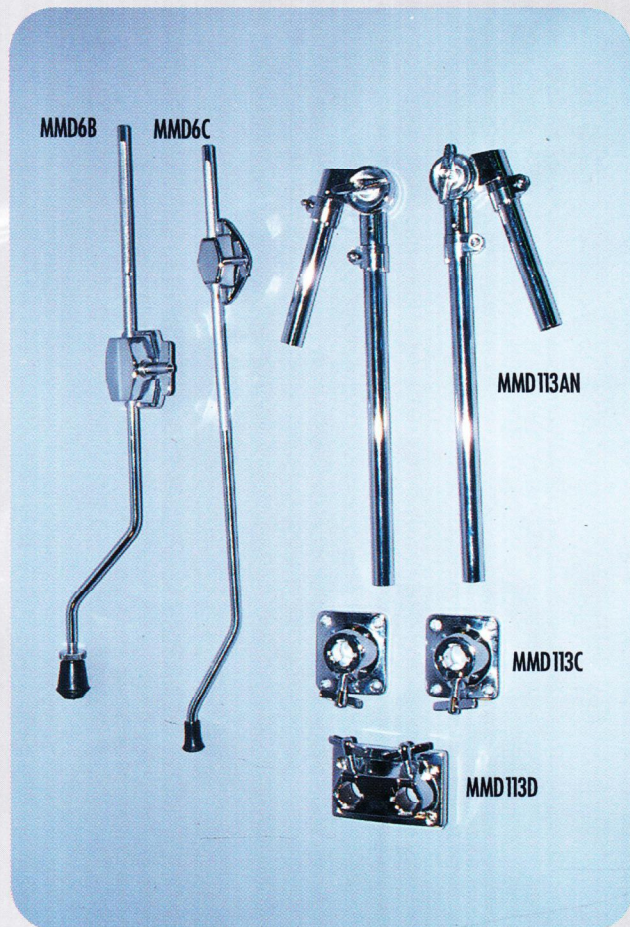



Gig Bags...

Deluxe Series

Tough Cordura® nylon Gig Bag with plush lined inside. Interior reinforcement for added protection against tremolo and machine heads damage. Heavy duty double shoulder strap makes for easy traveling, plus strong threaded handles and accessory compartment.



MMBCW2
MMBCE3
MMBCB4

Series 5

High tensile strength nylon, 5mm padded Gig Bag. Added feature: felt lined interior, shoulder and hand held strap for convenience, full zipper for easy access and accessory pouch.



GB-1
BB-2
JWB-1
CG-1

Economy Series

Durable waterproof rubberized nylon Gig Bag with accessory pouch.



EB100
EBB120
EJW130

Heavy duty high tensile strength nylon, 20 mm Alto Sax and Trumpet Gig Bag. Features red plush lining, shoulder and side handles, and neck pouch. Protect your brass instruments



SX10DX TB10DX

...& Stands

A328 Electric -Bass
A329 Accoustic
A frame stands for electric and acoustic guitars are space savers as well as a very sturdy heavy duty stand.



179B

A328
A329



179B
The tubular stand, America's most popular stand, is ideal for all guitars or basses.

PERFORMANCE MIGHTY MITE QUALITY

2000

Pre-Wired

Pickguard Assembly

Cut out the headaches by modifying your guitar or bass with our Pre-wired Pickguard Assembly. Assembly includes exclusive Mighty Mite® Pickups with covers, volume and tone control pot and knobs, switches, and jacks.

Replacement Pickups

A. Warm responsive covered Alnico Vintage Humbucking Pickups

| | | |
|----------|------------------------|---------|
| MMHA-F/C | Neck Position-Chrome | \$35.00 |
| MMHA-F/G | Neck Position-Gold | \$39.95 |
| MMHA-R/C | Bridge Position-Chrome | \$35.00 |
| MMHA-R/G | Bridge Position-Gold | \$39.95 |

B. Traditional P Bass® Style Split Pickup with clear bright tone.

| | | |
|--------|----------------------|---------|
| MMPB-4 | P-Bass® Split Pickup | \$39.95 |
|--------|----------------------|---------|

C. Our vintage Alnico Telecaster® Pickups present a full, smooth tone.

| | | |
|-----------|------------------------|---------|
| MMTLP-F/C | Neck Position-Chrome | \$29.95 |
| MMTLP-F/G | Neck Position-Gold | \$29.95 |
| MMTLP-R | Bridge Position Pickup | \$29.95 |

Hardware

D. Strat® Replacement Vintage Tremolo Saddles.

| | | |
|---------|--------------|--------|
| MM1100S | Package of 6 | \$8.95 |
|---------|--------------|--------|

E. This 1/4" Mono Output Jack will accept standard 1/4" plugs, however, it will require a 3/8" diameter mounting hole. (Mounting nut and flat washer is included.)

| | | |
|-------|--------|--------|
| MM113 | Chrome | \$2.95 |
|-------|--------|--------|

F. Mighty Mite® Strat® Replacement Single Coil Pickup Covers

| | | |
|---------|---------------------|--------|
| MM320B | Black-Package of 3 | \$5.95 |
| MM320W | White-Package of 3 | \$5.95 |
| MM320CR | Cream- Package of 3 | \$5.95 |

G. 1 5/8" Roller Nut

| | | |
|---------|--------|--------|
| MM1600B | Black | \$9.95 |
| MM1600C | Chrome | \$9.95 |
| MM1660G | Gold | \$9.95 |

Acoustic Guitar Bone Saddle and Nut

| | | |
|-----------|--------|---------|
| H. MM2410 | Saddle | \$12.95 |
|-----------|--------|---------|

| | | |
|-----------|--------------|---------|
| I. MM2516 | 1 11/16" Nut | \$12.95 |
|-----------|--------------|---------|

J. Universal Replacement Drum Key-Chrome

| | | |
|---------|---------------------------|---------|
| MMDK024 | Package of 2 | \$4.95 |
| MMDK060 | Bulk Package of 60 pieces | \$65.00 |

NEW PRODUCTS

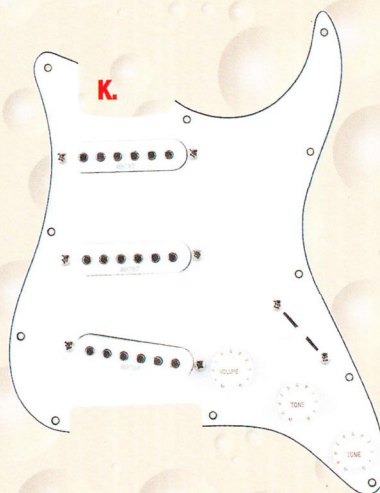

| | | |
|-----------|--|---------|
| K. MM400W | SSS White Pickguard with White Hardware | \$59.95 |
| MM400B | SSS Black Pickguard with Black Hardware | \$59.95 |
| MM400TS | SSS Tortoise Pickguard with White Hardware | \$59.95 |

| | | |
|-----------|--|---------|
| L. MM405W | SSH White Pickguard with White Hardware | \$65.00 |
| MM405B | SSH Black Pickguard with Black Hardware | \$65.00 |
| MM405TS | SSH Tortoise Pickguard with White Hardware | \$65.00 |

| | | |
|-----------|---|---------|
| M. MM410W | P-Bass® Style White Pickguard with Chrome Hardware | \$49.95 |
| MM410B | P-Bass® Style Black Pickguard with Chrome Hardware | \$49.95 |
| MM410TS | P-Bass® Style Tortoise Pickguard with Chrome Hardware | \$49.95 |

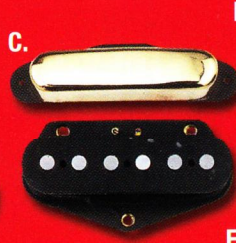
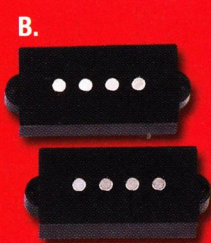
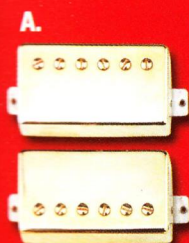

Drum Parts Kit

K. Everything needed for that quick repair. Parts fit most drum sets. Kit includes tension rods in various sizes, wingnuts, drum keys, etc... stored in a heavy-duty reusable storage case. Replenishment stock is available.

MMDK1

\$369.95



Bodies & Necks

L. P-Bass® Replacement 5 String Sanded and Sealed Maple Body.

MM2701

\$180.00

M. NEW Finished Strat® and Tele® Ash Bodies.

MM2700AF Strat® Replacement Body

\$245.00

MM2705AF Tele® Replacement Body

\$245.00

Only available in Black, See Through Red, See Through Purple

N. Strat® replacement left handed maple neck with maple fingerboard. This finished and ready to mounted neck has a scale length of 25 1/2", 22 frets, 12" radius, 1 5/8" nut.

MM2902L Licensed by Fender®!

\$125.00

Wilkinson® V50 Style Replacement Tremolo System.

O. Height adjustable stainless steel saddles. Threaded posts and bushing, arm springs, spring claw and allen wrenches are included.

MM1128 Chrome

\$69.95

MM1130 Gold

\$89.95

(Tremolo arms are also sold separately)

MM1308C Chrome

\$6.50

MM1308G Gold

\$7.95

Contemporary Tele® Bridge

P. This contemporary Tele® Bridge will replace most vintage Tele® Bridges to give your guitar an attractive updated look.

MM2112 Chrome

\$9.95

Machine Heads

Q. Traditional Fender® Style 5 String Bass Machine Heads.

MM6013B Black

\$45.00

MM6013C Chrome

\$45.00

The Buddha Rope

Your Secret Weapon for Super Chops

R. Bill "The Buddha" Dickens created this unconventional, string-dampening practice aid nearly two decades ago and has been using it as an accelerated technique builder ever since.

BR-1

\$8.95

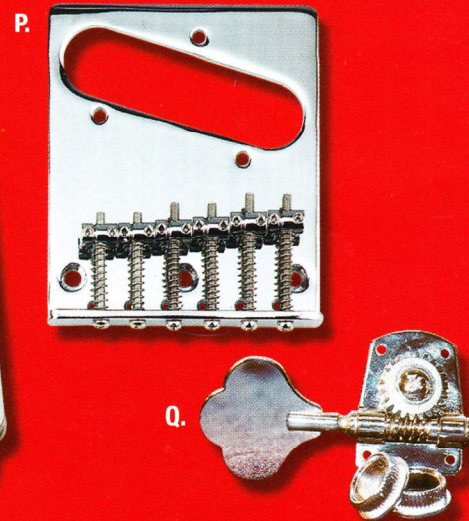
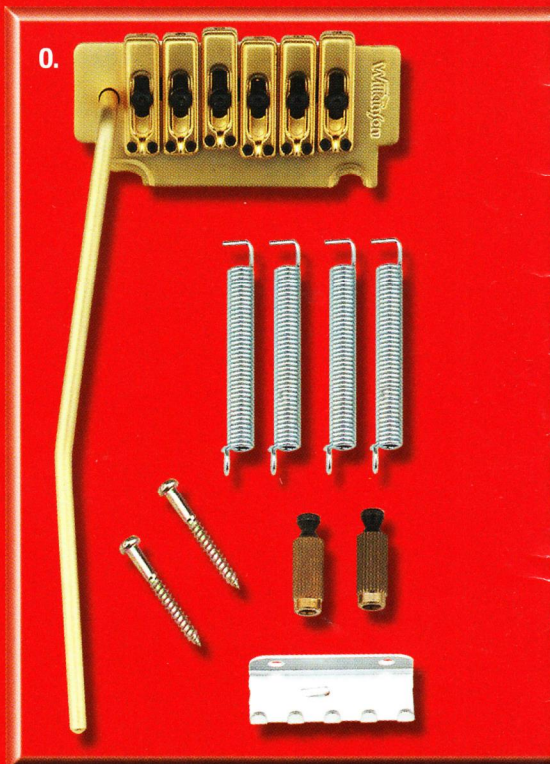
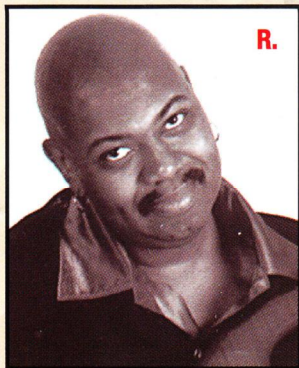

PLEASE DIRECT ALL INQUIRES TO:

3451 W. Commercial Avenue • Northbrook, IL 60062 USA

Phone: 847/498-MITE Fax: 847/498-5370

E-mail: mmiteparts@aol.com • Web: www.mightymite.com

Strat®, P-Bass®, Jazz Bass® and Telecaster® are trademarks of Fender Musical Instruments Corp., MIGHTY MITE® is not affiliated with Fender Musical Instruments Corp., Steinberger® and Les Paul® are trademarks of Gibson Musical Instruments Co., which is not affiliated with MIGHTY MITE® Parts. Floyd Rose® is not affiliated with MIGHTY MITE® Parts. Bigsby® is not affiliated with MIGHTY MITE® Parts. All Prices Subject to Change Without Notice.